

The reactions of ozone with cinnamic acids: formation and decay of 2-hydroperoxy-2-hydroxyacetic acid

2 PERKIN

Achim Leitzke, Erika Reisz,[†] Roman Flyunt[‡] and Clemens von Sonntag*

Max-Planck-Institut für Strahlenchemie, Stiftstrasse 34–36, P.O. Box 101365, D-45413, Mülheim an der Ruhr, Germany. E-mail: vonsonntag@mpi-muelheim.mpg.de; Fax: +49-208-306-3951; Tel: +49-208-306-3529

Received (in Cambridge, UK) 20th November 2000, Accepted 20th March 2001

First published as an Advance Article on the web 10th April 2001

In aqueous solution, ozone reacts with 4-methoxycinnamate, cinnamate and 4-nitrocinnamate with rate constants of 6.8×10^5 , 3.8×10^5 and $1.2 \times 10^5 \text{ dm}^3 \text{ mol}^{-1} \text{ s}^{-1}$, respectively. The corresponding acids react somewhat more slowly. In product studies, material balance with respect to ozone consumption has been obtained. In the case of cinnamic acid and its 4-methoxy derivative, glyoxylic acid, H_2O_2 and the corresponding benzaldehydes are formed. In contrast, 4-nitrocinnamic acid affords, besides a full yield of 4-nitrobenzaldehyde, 70% glyoxylic acid and 30% formic acid, while the H_2O_2 yield is also reduced to 70%. These results can be explained if in the latter case the Criegee intermediate decomposes not only into glyoxylic acid and 1-hydroperoxy-1-phenylmethanol (which rapidly releases H_2O_2 yielding 4-nitrobenzaldehyde, $k > 0.5 \text{ s}^{-1}$), but also, to an extent of 30%, into 4-nitrobenzaldehyde and 2-hydroperoxy-2-hydroxyacetic acid. This product has been produced independently by ozonating fumaric acid and has been shown to decompose rapidly ($k > 1 \text{ s}^{-1}$) into formic acid and CO_2 . The reaction of H_2O_2 with the free carbonyl form of glyoxylic acid, present at 1.8% in equilibrium with its hydrate, is comparatively slow ($k = 0.3 \text{ dm}^3 \text{ mol}^{-1} \text{ s}^{-1}$, based on total glyoxylic acid concentration). The reaction of the stronger nucleophile HO_2^- , present in basic solutions, is considerably faster ($k = 1700 \text{ dm}^3 \text{ mol}^{-1} \text{ s}^{-1}$). Thus, in the cinnamate system, the substituents markedly influence the fate of the Criegee intermediate, although they have only a small influence on the rate of the ozone reaction.

Ozone is a strongly electrophilic agent.¹ In its reactions with olefins, the rate of reaction drops by as much as seven orders of magnitude on going from tetramethylethene to tetrachloroethene, and the substituents have also a dramatic effect on the subsequent decay routes of the Criegee intermediate formed in the first step [cf. Scheme 1 reactions (1)–(5)].² In simple olefins,

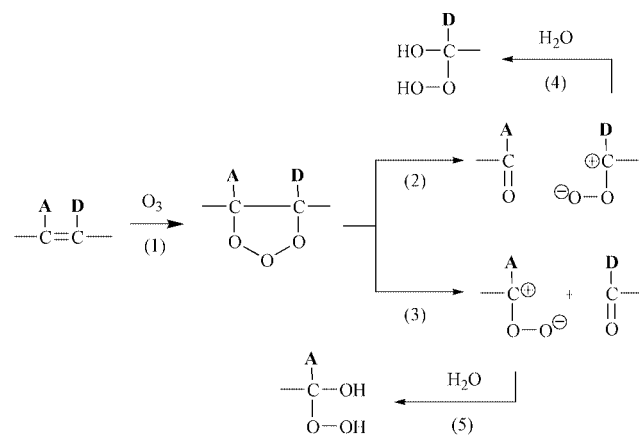

Scheme 1

electron-donating groups D such as a methyl substituent favour the formation of the α -hydroxyhydroperoxide at this position [reactions (2) and (4)].² This has been rationalised by a stabilisa-

tion of the carbocation formed in reaction (2). The presence of an electron-accepting substituent A can enhance this effect as it disfavors the formation of a cation at the α -position [reaction (3)], shifting the reaction in this example practically fully towards pathway (2).

In our ongoing study on the ozone-induced degradation of lignins, which contribute to an important extent to the effluents of the paper industry, we were confronted with the fact that reactions of aromatic compounds with ozone are as yet poorly understood. In all cases where an attempt has been made to determine the reaction products, material balance has not been obtained (e.g. refs. 3–9), and we encounter similar problems in our ongoing investigations of the ozonolysis of phenol and related compounds.

Aromatic compounds with a conjugated double bond, e.g. coniferyl alcohol, are important building blocks of lignin, and to a small extent such structural elements may also be present in this polymer. The reaction of ozone with this kind of C=C double bond would lead to a chain scission of the polymer, a desirable event in the degradation process.

For the study of this type of reaction, the water-soluble cinnamic acids can serve as models. The parent acid and 4-methoxy- and 4-nitro-cinnamic acids are commercially available, as are the final products that are expected to be formed upon ozone treatment. The rate constant of the reaction of cinnamic acid with ozone has been determined before.⁹ From its high rate of reaction (cf. Table 1) one has to assume that ozone reacts with the conjugated double bond rather than with the aromatic ring.

In the present paper, we will show that a substituent in the aromatic ring can influence markedly the fate of the Criegee intermediates. This will require a detailed study of the formation and decay of 2-hydroperoxy-2-hydroxyacetic acid that has already troubled to some extent mechanistic interpretations in

[†] On leave from the Faculty of Industrial Chemistry and Environmental Engineering, Technical University of Timisoara, Bul. Victoriei 2, 1900 Timisoara, Romania.

[‡] On leave from the Institute of Physico-Chemistry, National Academy of Science of the Ukraine, Naukova Street 3a, UA-79053 L'viv, Ukraine.

Table 1 Rate constants (in units of $\text{dm}^3 \text{mol}^{-1} \text{s}^{-1}$) of ozone with some cinnamic acids

Substrate	Acid	Anion	Reference
Cinnamic acid	1×10^5	1.2×10^6	Ref. 9
	5×10^4	3.8×10^5	This work
4-Methoxycinnamic acid	1.3×10^5	6.8×10^5	This work
4-Nitrocinnamic acid	—	1.2×10^5	This work
3-Methoxy-4-hydroxycinnamic acid	1.1×10^6	7.9×10^6	Ref. 9
3,4-Dihydroxycinnamic acid	2×10^6	1.2×10^7	Ref. 9

earlier studies on ozonation reactions^{8,10,11} and on the $\cdot\text{OH}$ -induced degradation of EDTA,¹² where the involvement of this short-lived intermediate was postulated.

Experimental

Cinnamic acid (>99%, Merck), 4-methoxycinnamic acid ($\geq 98\%$, Fluka) and 4-nitrocinnamic acid ($\geq 97\%$, Fluka), glyoxylic acid monohydrate sodium salt (>99%, Fluka) and fumaric acid (disodium salt, 98%, Aldrich) were used as received. Benzaldehyde and its 4-methoxy and 4-nitro derivatives, required as reference materials, were also commercially available. Benzaldehyde contained some benzoic acid and was redistilled. Catalase (from beef liver) was obtained from Boehringer Mannheim.

Solutions were made-up in Milli-Q-filtered (Millipore) water. Ozone stock solutions were prepared by bubbling ozone from a dioxygen-fed ozonator (Wedeco SWO-70 or Philaqua Philoz 04) for some minutes through water, and its ozone content was determined spectrophotometrically taking $\epsilon(260 \text{ nm})^{13,14} = 3300 \text{ dm}^3 \text{mol}^{-1} \text{cm}^{-1}$. Experiments were carried out at room temperature (20–21 °C) and in the absence of buffer. In most experiments, the cinnamic acid was in large excess over the added ozone concentration (cinnamic acid consumption <15%). Due to the high rate constant of the reaction of cinnamic acid with ozone (*cf.* Table 1) compared to those of the products benzaldehyde ($k = 2.5 \text{ dm}^3 \text{mol}^{-1} \text{s}^{-1}$)¹⁵ and glyoxylate ion ($k = 1.9 \text{ dm}^3 \text{mol}^{-1} \text{s}^{-1}$),¹⁵ the consumption of cinnamic acid could also be determined at high conversion.

The concentrations of benzaldehydes were determined by HPLC (Merck-Hitachi with diode array detection) on a 25 cm RP18 reversed phase column [eluent: water containing 40% methanol and 0.1% phosphoric acid; retention times (min): cinnamic acid (19), 4-methoxycinnamic acid (22), 4-nitrocinnamic acid (16), benzaldehyde (8), 4-methoxybenzaldehyde (10), 4-nitrobenzaldehyde (7.5)]. The benzoic acids elute sufficiently distant from the benzaldehydes, and low concentrations of these potential by-products can be detected without interference. Glyoxylic and formic acids were determined by ion chromatography [Dionex DX 100; column: AS9 HC; eluent: $1 \times 10^{-2} \text{ mol dm}^{-3} \text{NaHCO}_3$; retention times (min): glyoxylic acid (10.5), formic acid (11.5)]. Hydrogen peroxide was determined with molybdate-activated iodide.¹⁶

Since H_2O_2 reacts with glyoxylic acid giving rise to formic acid and carbon dioxide (see below), catalase was added (10 μl per 10 ml sample) right after ozonolysis to destroy H_2O_2 . Under our experimental conditions, its destruction was complete within less than 3 s (absence of any residual H_2O_2).

In the competition¹⁷ between the cinnamic acids and buten-3-ol for ozone, formaldehyde is the measured product which was determined with the help of the Hantzsch reaction.¹⁸ The error in these determinations was typically less than $\pm 10\%$.

NMR data were taken on a Bruker DRX 400 instrument and UV spectra on a Perkin Elmer Lambda 16 spectrophotometer. The rate constant for the reaction of buten-3-ol was redetermined by the stopped-flow (Biologic SFM3) technique by following the decay of the ozone absorption at 260 nm as a function of time.

Results and discussion

Rate constants

The cinnamic acids under investigation have $\text{p}K_a$ values between 4.1 and 4.6.^{9,19} The free acids, especially 4-nitrocinnamic acid, are poorly soluble in water, and for this reason only the reactions of their anions have been investigated in some detail. The rate constants for the reactions of ozone with the cinnamate ions were determined by competition¹⁷ with buten-3-ol by following the formaldehyde yield [*cf.* reaction (6)] as a function of the [cinnamic acid]/[buten-3-ol] ratio (*cf.* ref. 17). The rate constant for the reaction of ozone with buten-3-ol is $7.9 \times 10^4 \text{ dm}^3 \text{mol}^{-1} \text{s}^{-1}$.²

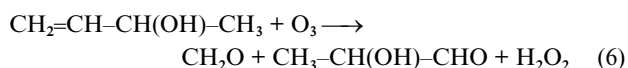

The rate constants thus obtained are compiled in Table 1. As expected, the electron-donating methoxy group in a *para*-position enhances the rate of reaction while the electron-withdrawing nitro group reduces it. From these three values it is estimated that the substituent effect on the rate of reaction, as expressed by the ρ value, is an order of magnitude lower than in the case of the ozone reaction with *para*-substituted benzenes ($\rho = -3.1$).¹ This clearly shows that the *para*-substituent at the aromatic ring has only a small effect on the reactivity of the conjugated double bond. In contrast, there can be quite a marked influence of the substituent on the fate of the Criegee intermediate (see below).

In the reactions of ozone, the reactivity of anions is generally higher than that of the conjugate acids, due to a higher electron density in the C=C double bond.¹⁵ This is also observed for the present system (*cf.* Table 1).

It is noticed that there is a substantial difference between the rate constants determined by competition (this study) and those by continuous flow using indigotrisulfonic acid as a detector for residual ozone (ref. 9). These differences (a factor of 2–3) are larger than the confidence limits of these methods. In an attempt to solve this discrepancy, we have redetermined the rate constant of the reaction of ozone with buten-3-ol, but our more recent value ($k = 9.1 \times 10^4 \text{ dm}^3 \text{mol}^{-1} \text{s}^{-1}$) does not materially alter the situation. Hence, we do not have an explanation for this discrepancy.

Products

With all of the cinnamic acids investigated, one mol of cinnamic acid is consumed per mol ozone (data not shown), and in the case of cinnamic acid one mol of benzaldehyde and one mol of glyoxylic acid are formed (Fig. 1 and Table 2). This also holds for 4-methoxycinnamic acid (data not shown), while in the case of 4-nitrocinnamic acid some formic acid instead of glyoxylic acid (plus CO_2 , not determined here) is formed; the sum of the two acids, however, again corresponds to the 4-nitrobenzaldehyde yield (Fig. 1). In this context it is worth mentioning that also in the case of 4-hydroxycinnamic acid (*p*-cumaric acid), 4-hydroxybenzaldehyde and glyoxylic acid are the major products.⁴

Formation and decay of 2-hydroperoxy-2-hydroxyacetic acid

When an ozonated cinnamate solution (pH ~ 6.5) is kept for some time, glyoxylic acid is progressively converted into formic acid due to the presence of H_2O_2 which is thereby consumed (data not shown, for the kinetics of this reaction see Fig. 2).

Hydrogen peroxide and glyoxylic acid [in aqueous solution mainly present as its hydrate, *cf.* Scheme 2, equilibrium (7), for details see below] give rise to 2-hydroperoxy-2-hydroxyacetic

Table 2 Product yields (mol per mol of ozone) in the reaction of ozone with cinnamate ions at pH ~6.5

Substrate	Benzaldehyde	Glyoxylic acid	Formic acid	H ₂ O ₂
Cinnamic acid	1.0	1.0	—	1.0
4-Methoxycinnamic acid	1.05	1.0	—	1.0
4-Nitrocinnamic acid	0.94	0.7	~0.3	0.7

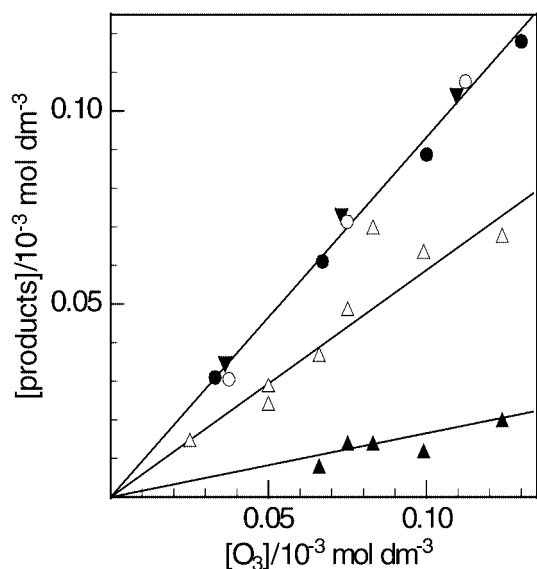
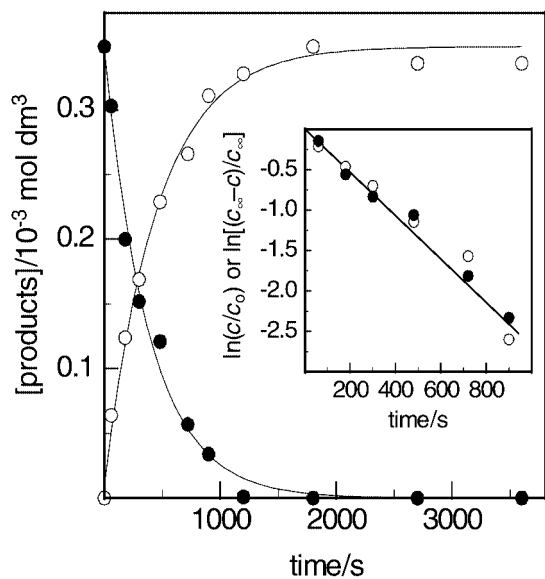
**Fig. 1** Ozonolysis of cinnamate (●, ○) and 4-nitrocinnamate ions (▼, ▲, △) in aqueous solution, pH ~6.5. Formation of benzaldehyde (●), 4-nitrobenzaldehyde (▼), glyoxylic acid (○, △) and formic acid (▲) as a function of the ozone concentration.**Fig. 2** Decrease of glyoxylic acid (●; starting concentration 3.5×10^{-4} mol dm⁻³) and formation of formic acid (○) as a function of time in the presence of H₂O₂ (5×10^{-3} mol dm⁻³) at pH 7.2. Inset: the same data in a logarithmic plot.

acid [Scheme 2, reactions (8) and (9)] whose anion decarboxylates into formic acid and carbon dioxide [Scheme 2, reaction (10)].^{8,11,12,20}

Very little was known about the kinetics of this reaction. In the ozonolysis of the cinnamic acids, 2-hydroperoxy-2-hydroxyacetic acid is a potential intermediate, and for the elucidation of the mechanism of the ozonolysis of the cinnamic acids, a detailed study of the formation and decay of this intermediate was required.

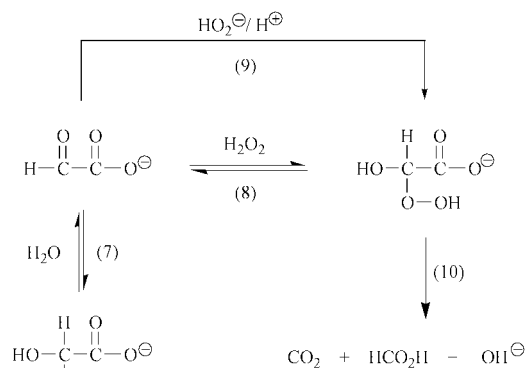
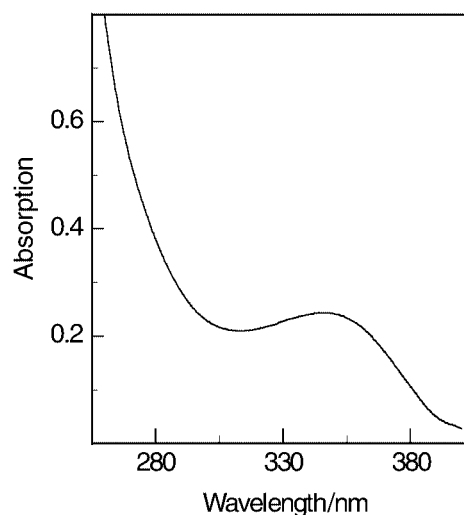
**Scheme 2****Fig. 3** UV absorption spectrum of an aqueous solution of sodium glyoxylate (0.2 mol dm⁻³).

The ¹H NMR spectrum of glyoxylic acid in D₂O shows a strong signal at $\delta = 5.04$ ppm (attributed to the hydrate form) and a much weaker one at $\delta = 9.35$ ppm (attributed to the aldehyde form). The presence of the free aldehyde in small amounts is supported by the UV spectrum (Fig. 3), which shows the typical $n \rightarrow \pi^*$ transition of the carbonyl function at ~345 nm.

These $n \rightarrow \pi^*$ transitions are rather weak, and their absorption coefficients are typically only ~ 50 dm³ mol⁻¹ cm⁻¹, *i.e.* a relatively high concentration is required for its detection (for the determination of the open-chain forms in carbohydrates with the help of this long-wavelength absorption band, see ref. 21). From the NMR data, one can calculate that at room temperature ~1.8% of the glyoxylate ions are present in the aldehyde form. On this basis, the absorption coefficient of its $n \rightarrow \pi^*$ transition is calculated to be ~ 65 dm³ mol⁻¹ cm⁻¹, in good agreement with expectation.

For the formation of the 2-hydroperoxy-2-hydroxyacetic acid, the free carbonyl form is required [*cf.* Scheme 2, reaction (8)], and since the anion of H₂O₂, HO₂⁻, is a much better nucleophile, in alkaline solution the rate of reaction should increase with pH [$pK_a(\text{H}_2\text{O}_2) = 11.8$]. As shown in Fig. 4, this is indeed the case. At pH > 10.7 the rate of reaction became too fast to be

Table 3 Compilation of rate constants concerning formation and decay of 2-hydroperoxy-2-hydroxyacetic acid

Reaction	Rate constant
$\text{H}_2\text{O}_2 + \text{HC(O)CO}_2^- / \text{HC(OH)}_2\text{CO}_2^- \longrightarrow \text{HC(OH)(OOH)CO}_2^-$	$0.3 \text{ dm}^3 \text{ mol}^{-1} \text{ s}^{-1a}$
$\text{H}_2\text{O}_2 + \text{HC(O)CO}_2^- \longrightarrow \text{HC(OH)(OOH)CO}_2^-$	$16.5 \text{ dm}^3 \text{ mol}^{-1} \text{ s}^{-1}$
$\text{HO}_2^- + \text{HC(O)CO}_2^- / \text{HC(OH)}_2\text{CO}_2^- \longrightarrow \text{HC(OH)(OOH)CO}_2^-$	$1.7 \times 10^3 \text{ dm}^3 \text{ mol}^{-1} \text{ s}^{-1a}$
$\text{HO}_2^- + \text{HC(O)CO}_2^- \longrightarrow \text{HC(OH)(OOH)CO}_2^-$	$9.4 \times 10^4 \text{ dm}^3 \text{ mol}^{-1} \text{ s}^{-1}$
$\text{HC(OH)(OOH)CO}_2^- \longrightarrow \text{CO}_2 + \text{HCO}_2\text{H} + \text{OH}^-$	$>1 \text{ s}^{-1}$

^a Observed overall rate constants.

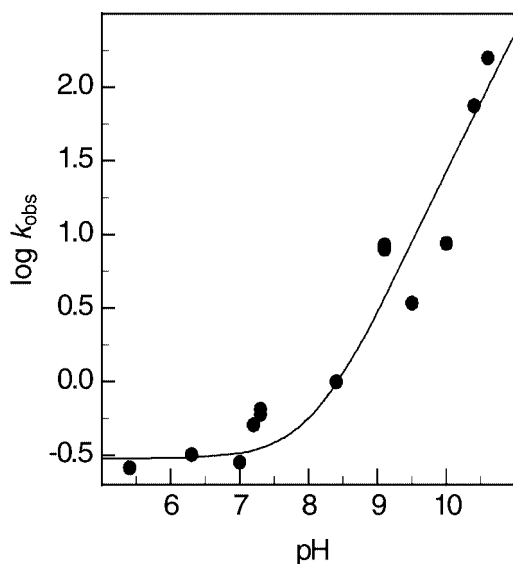

Fig. 4 The logarithm of the observed second-order rate constant of the reaction of glyoxylic acid with H_2O_2 as a function of pH. The solid line is calculated on the basis of the data given in the text.

measurable with confidence, *i.e.* the expected levelling into a plateau above the $\text{p}K_a$ of H_2O_2 could not be verified.

The data shown in Fig. 4 were obtained under the conditions of pseudo-first-order kinetics, *i.e.* either by following the decrease of glyoxylic acid and the corresponding formation of formic acid in the presence of a tenfold excess of H_2O_2 as a function of time (*cf.* Fig. 2) or by following the decay of H_2O_2 in the presence of an excess of glyoxylic acid. The latter approach has mainly been used at high pH where the reaction became too fast for the other technique. Experiments in which only either the total concentration of glyoxylic acid or that of its free carbonyl form were in tenfold excess yielded the same rate constant. This is an indication that under these experimental conditions equilibrium (7) (Scheme 2) is quickly re-established, and the reaction with H_2O_2 cannot deplete the free carbonyl form significantly.

According to the data shown in Fig. 4, the kinetics of the reaction of glyoxylic acid with H_2O_2 is given by eqn. (11), whereby k_{obs} is the observed second-order rate constant.

$$k_{\text{obs}} = k_8 \times [\text{H}_2\text{O}_2] + k_9 \times [\text{HO}_2^-] \quad (11)$$

The solid line through the data points has been calculated on the basis of the $\text{p}K_a$ value of H_2O_2 , $k_8 = 0.3 \text{ dm}^3 \text{ mol}^{-1} \text{ s}^{-1}$ and $k_9 = 1.7 \times 10^3 \text{ dm}^3 \text{ mol}^{-1} \text{ s}^{-1}$. These rate constants have been calculated on the basis of the total glyoxylic acid concentration. If one takes into account that the species relevant for the observed reaction is the free carbonyl form present at only 1.8%, then these values have to be multiplied by a factor of 55 to obtain the rate constants of the carbonyl form (for a compilation of rate constants see Table 3).

The question of how fast the 2-hydroperoxy-2-hydroxyacetate ion decomposes and whether the reverse of the H_2O_2 addition [*e.g.* Scheme 2, equilibrium (8)] should be taken

into account was addressed by generating 2-hydroperoxy-2-hydroxyacetic acid *via* the ozonation of fumaric (or maleic) acid [Scheme 3, reactions (12) and (13)] (for earlier studies, see refs. 10,22,23).

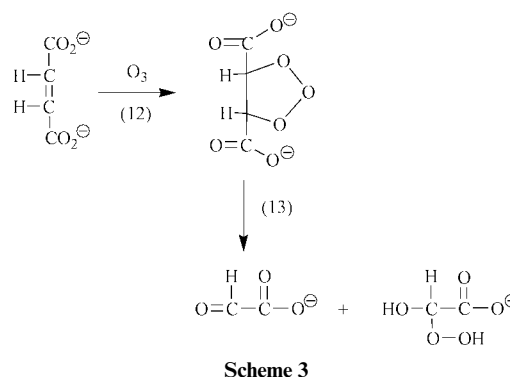

Scheme 3

Immediate analysis by ion chromatography revealed that one mol of glyoxylic acid and one mol of formic acid per mol ozone are present shortly after ozonation, *i.e.* once 2-hydroperoxy-2-hydroxyacetic acid is formed it rapidly decomposes into CO_2 and formic acid [Scheme 3, reaction (10)]. In fact, when immediately ($<1 \text{ s}$) after ozonolysis ($k = 50 \text{ s}^{-1}$ under these conditions) molybdate-activated iodide (which reacts with hydrogen peroxide within a few seconds under these conditions)² was added, no more peroxidic material was detected ($k_{10} > 1 \text{ s}^{-1}$). Thus, the hydrolysis of 2-hydroperoxy-2-hydroxyacetic acid into glyoxylic acid and hydrogen peroxide [Scheme 2, back reaction (–8)], must be slow in comparison.

Mechanistic aspects

The lack of immediate formation of formic acid in the ozonation of cinnamic acid and 4-methoxycinnamic acid shows that reaction (16) (Scheme 4) does not occur and hence strongly favours pathway (15) (Scheme 4) in these two cases.

However, with 4-nitrocinnamic acid, the presence of ~30% formic acid right after ozonation (*cf.* Table 1 and Fig. 1) strongly indicates that the electron-withdrawing property of the nitro group disfavors the formation of the benzylic carbocation as shown in reaction (3) (Scheme 1) and thus reaction (16) [for the potential intermediate see reaction (3)] occurs now as well (~30%) in competition with the still favoured reaction (15) (~70%).

The generally most prominent α -hydroxyhydroperoxides are the benzylic ones [*cf.* reaction (15)]. In contrast to α -hydroxyalkylhydroperoxides,² these species must be very short-lived, certainly too short-lived to be detectable by HPLC, which only showed peaks due to the benzaldehydes. In order to facilitate the determination of their lifetime, catalase was added 1 second after ozonation of a cinnamate solution, and 3 seconds after molybdate-activated iodide had been added. Only 5% of the originally formed α -hydroxyhydroperoxide survived under these conditions, indicating that reaction (17) (Scheme 5) must proceed with a rate constant $>0.5 \text{ s}^{-1}$. This estimate is valid since molybdate-activated iodide seems to inactivate

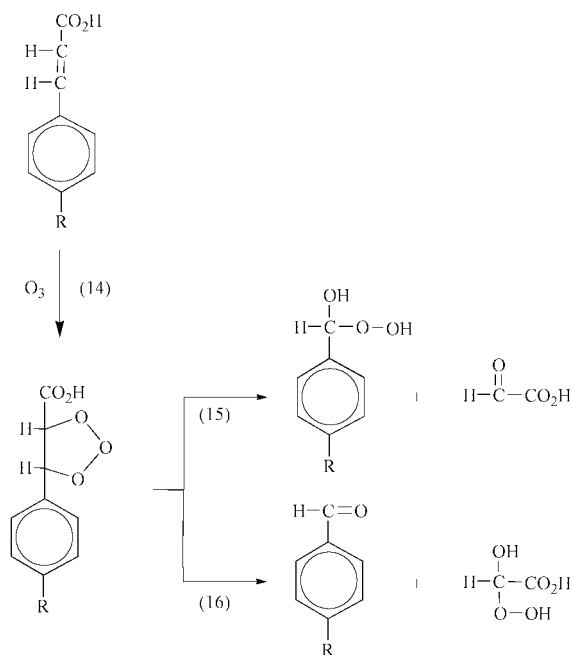

Scheme 4

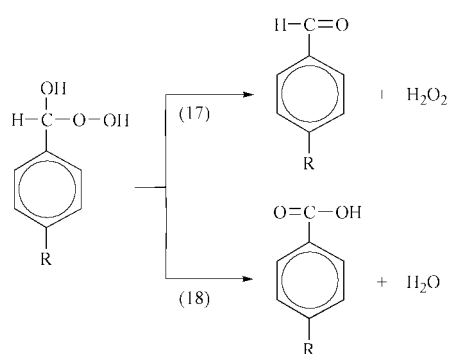

Scheme 5

catalase immediately, *i.e.* there is no competition between catalase and iodide, when catalase is added to the iodide solution prior to the addition of H_2O_2 .

In competition with hydrolysis [Scheme 5, reaction (17)], there is also a potential (proton-catalysed) water-elimination that would lead to the formation of benzoic acid [Scheme 5, reaction (18)].

This type of reaction may have occurred in the ozonolysis of phenol, where muconic acid (hexa-2,4-dienedioic acid) rather than muconic acid aldehyde (6-oxohexa-2,4-dienoic acid) is one of the major products.²⁴ For this reason, special attention has been paid to the potential formation of benzoic acid (4-methoxybenzoic acid) as a conceivable by-product, but even at pH 2 benzoic acids were not formed (<2%). Thus, this system does not allow us to study the competition of H_2O_2 release with water-elimination from α -hydroxyhydroperoxides, which continues to be an open question in ozone chemistry.

References

- 1 J. Hoigné and H. Bader, *Water Res.*, 1983, **17**, 173.
- 2 P. Dowideit and C. von Sonntag, *Environ. Sci. Technol.*, 1998, **32**, 1112.
- 3 B. Legube, S. Guyon, H. Sugimitsu and M. Doré, *Sci. Eng.*, 1983, **5**, 151.
- 4 R. Andreozzi, V. Caprio, G. D. D'Amore and A. Insola, *Water Res.*, 1995, **29**, 1.
- 5 R. Andreozzi, A. Insola, V. Caprio and M. G. D'Amore, *Water Res.*, 1992, **26**, 639.
- 6 C. H. Kuo and H. S. Soong, *Chem. Eng. J. (Lausanne)*, 1984, **28**, 163.
- 7 M. D. Gurol and R. Vatistas, *Water Res.*, 1987, **21**, 895.
- 8 Y. Yamamoto, E. Niki, H. Shiokawa and Y. Kamiya, *J. Org. Chem.*, 1979, **44**, 2137.
- 9 U. Jans, Doctoral thesis, ETH Zürich, 1996.
- 10 E. Gilbert, *Z. Naturforsch., B: Anorg. Chem. Org. Chem.*, 1977, **32**, 1308.
- 11 J. Etzel, Doctoral thesis, University of Karlsruhe, 1993.
- 12 B. Höbel and C. von Sonntag, *J. Chem. Soc., Perkin Trans. 2*, 1998, 509.
- 13 L. Forni, D. Bahnemann and E. J. Hart, *J. Phys. Chem.*, 1982, **86**, 255.
- 14 E. J. Hart, K. Sehested and J. Holcman, *Anal. Chem.*, 1983, **55**, 46.
- 15 P. Neta, R. E. Huie and A. B. Ross, *J. Phys. Chem. Ref. Data*, 1988, **17**, 1027.
- 16 A. O. Allen, C. J. Hochanadel, J. A. Ghormley and T. W. Davis, *J. Phys. Chem.*, 1952, **56**, 575.
- 17 F. Muñoz and C. von Sonntag, *J. Chem. Soc., Perkin Trans. 2*, 2000, 661.
- 18 T. Nash, *Biochem. J.*, 1953, **55**, 416.
- 19 D. D. Perrin, B. Dempsey and E. P. Serjeant, *pK_a Prediction for Organic Acids and Bases*, Chapman and Hall, London, 1981.
- 20 W. H. Hatcher and G. W. Holden, *Proc. Trans. R. Soc. Can.*, 1925, **19**, 11.
- 21 W. Funcke, C. von Sonntag and C. Triantaphylides, *Carbohydr. Res.*, 1979, **75**, 305.
- 22 Y. Yamamoto, E. Niki and Y. Kamiya, *J. Org. Chem.*, 1981, **46**, 250.
- 23 J. J. Pappas, W. P. Keaveney, E. Gancher and M. Berger, *Tetrahedron Lett.*, 1966, **36**, 4273.
- 24 E. Mvula and C. von Sonntag, unpublished results.